

ITEM: 0373

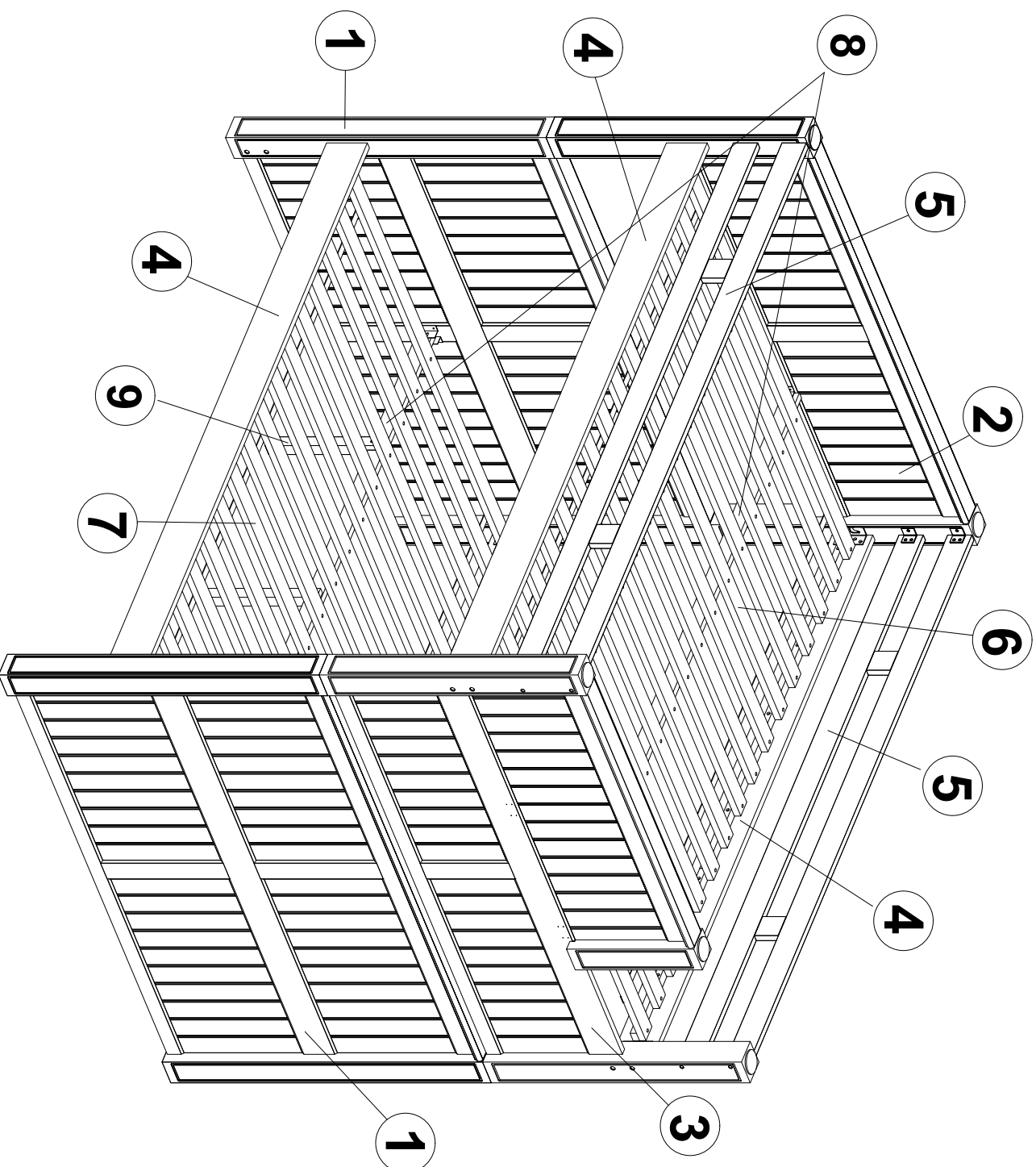



QUEEN/QUEEN BUNK





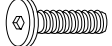
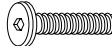

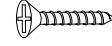
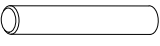
Part List:

Item	Description	Qty
1	Bottom Head Boards	2 pcs
2	Left Upper Head Board	1 pc
3	Right Upper Head Board	1 pc
4	Side Rails	4 pcs
5	Guard Rails	2 pcs
6	Upper Slat	1 set
7	Bottom Slat	1 set
8	Center Supports	3 pcs
9	Leg Supports	3 pcs



Hardware List:

Item	Description	Qty
A	JCBB M8 x 25 	16 pcs
B	JCBC M6 x 30 	8 pcs
C	Allen key M4 	1 pc
D	CSK screw M4 x 30 	118 pcs
E	Metal Pin 	4 pcs
F	Allen key M5 	1 pc

Item	Description	Qty
H	CSK screw M4 x 20 	24 pcs
I	CSK screw M4 x 15 	24 pcs
J	"L" Bracket 	8 pcs
K	"U" Bottom Bracket 	2 pcs
L	"U" Top Bracket 	4 pcs
M	Wood Cap 	5 pcs

step
1

DO NOT TIGHTEN SCREWS
BEFORE ALL PARTS ARE FULLY ASSEMBLED !!

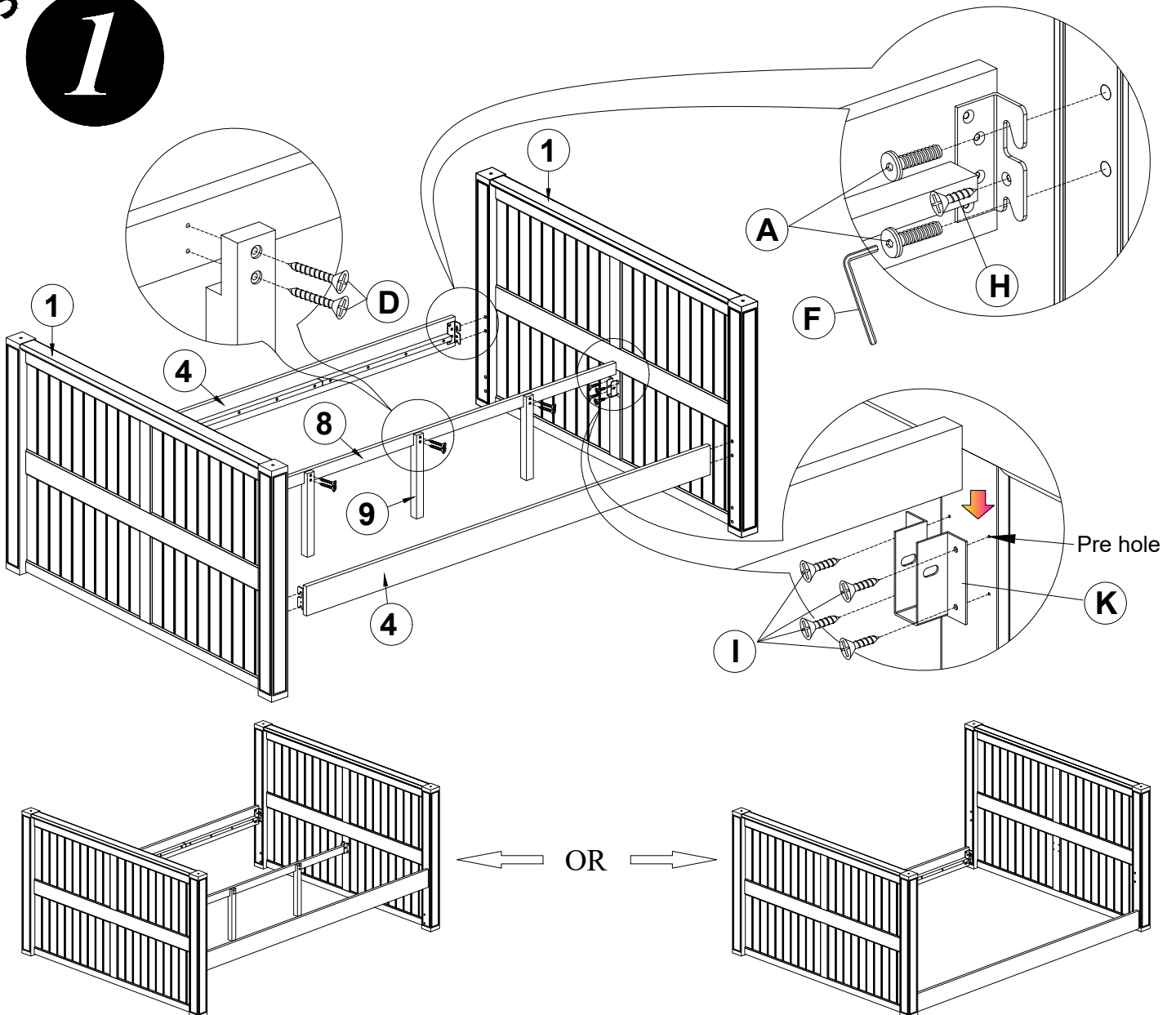

step 2

These two pre holes are for the L bracket

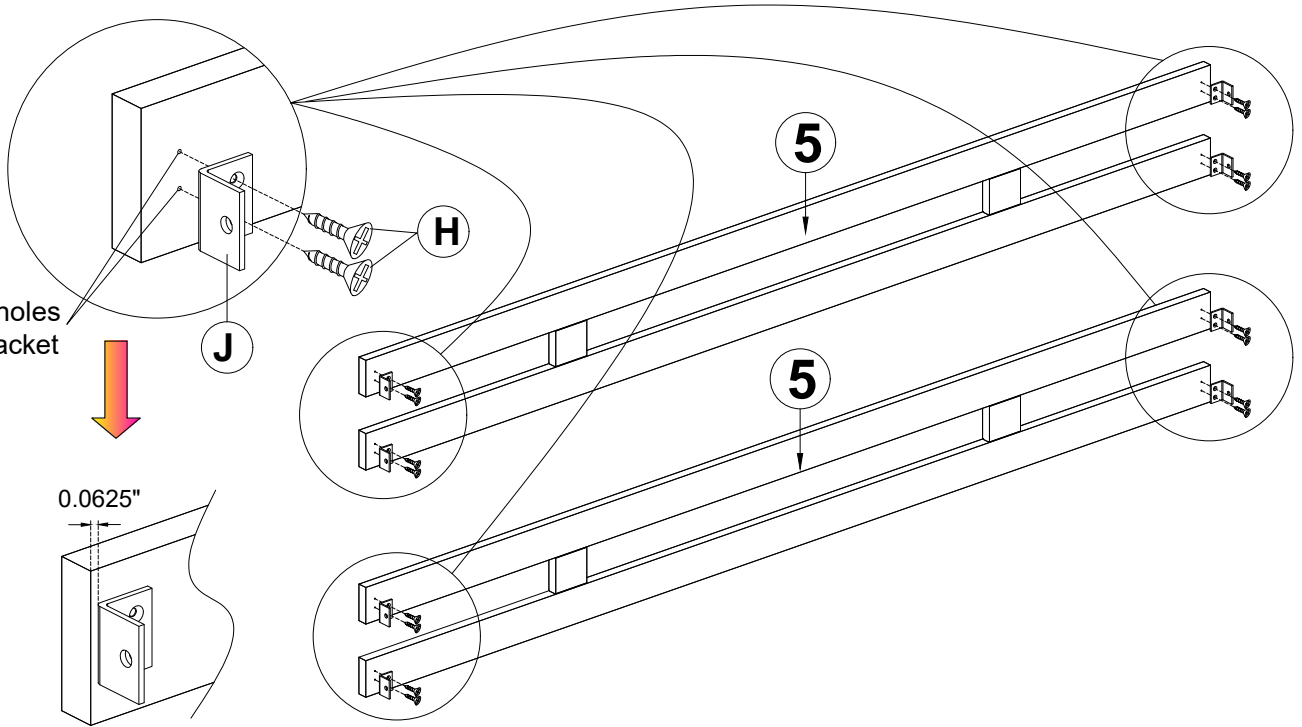

The right position of bracket is slightly inside from end of guard rail

step 3

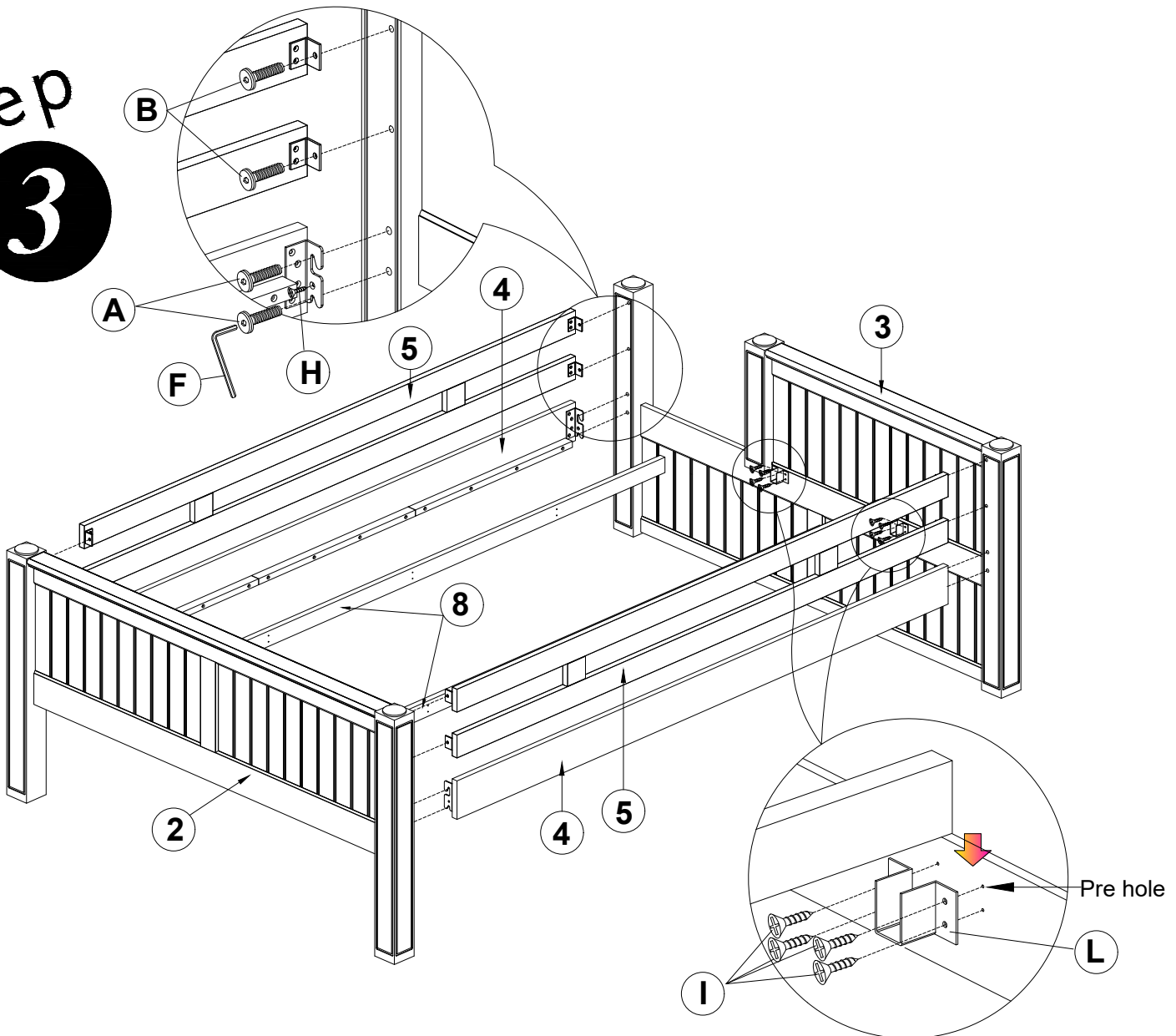

step
4

Install the center support
(Part 8) first, then secure
the slats.

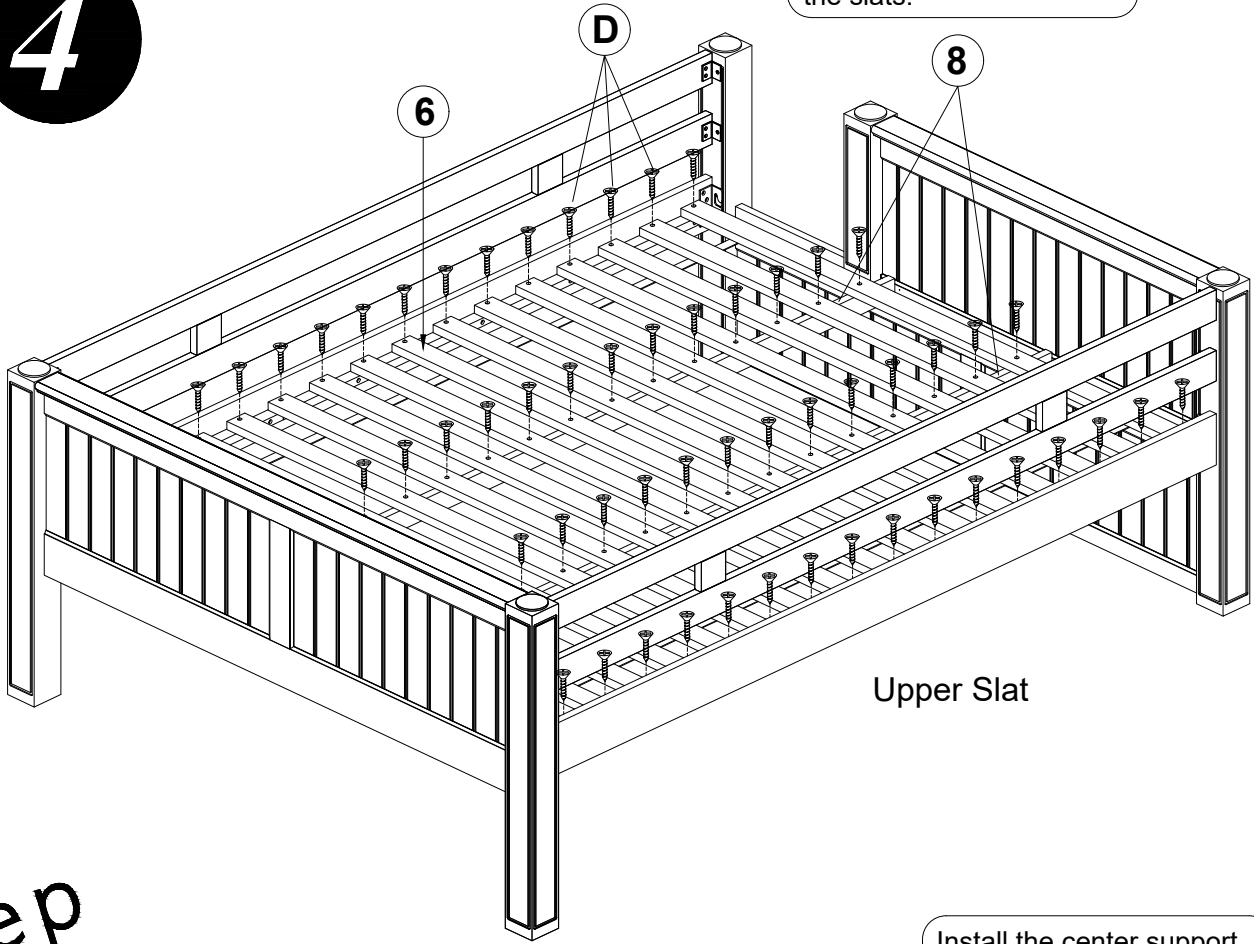

step
5

Install the center support
(Part 8) first, then secure
the slats.

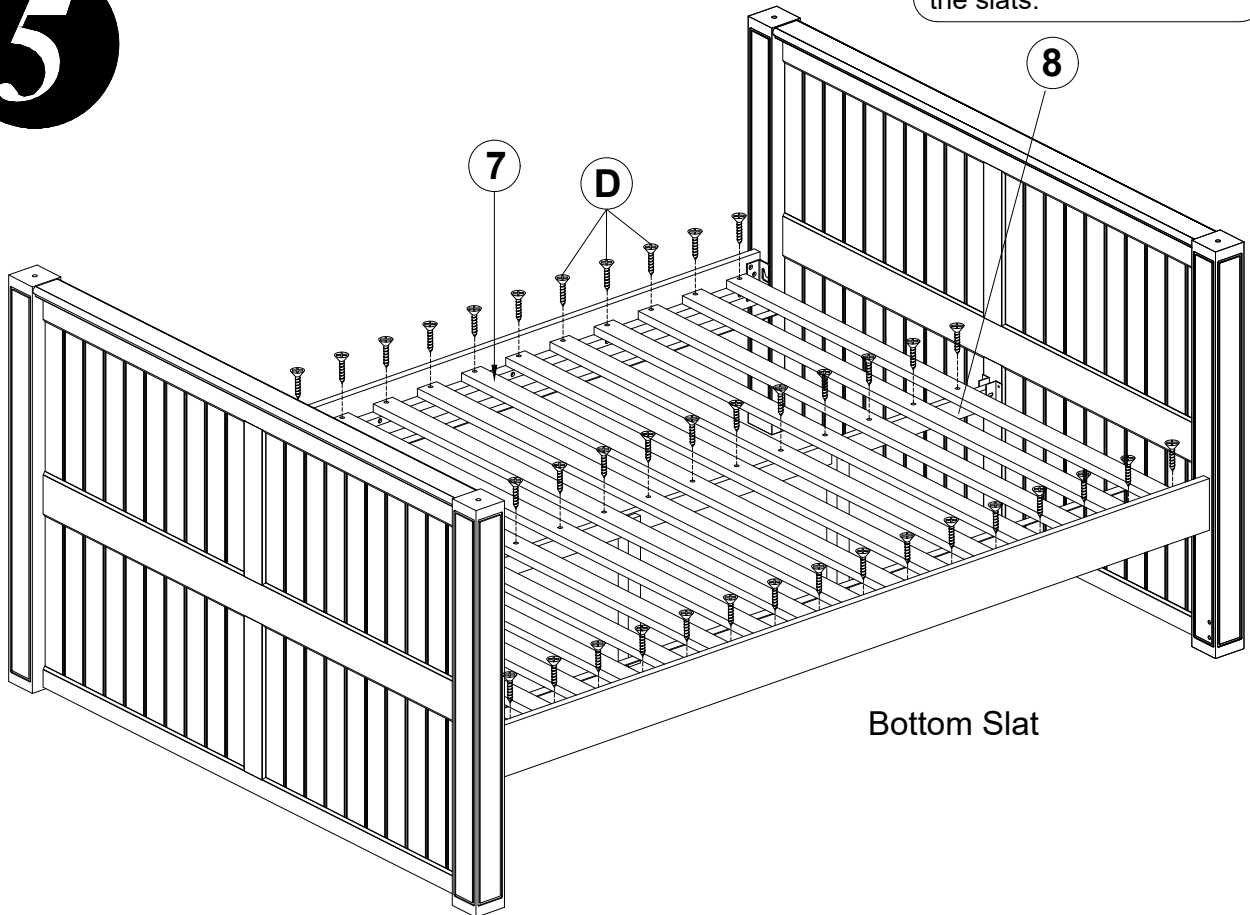

step
6

